

Physical-Layer Cross-Technology Communication via Emulation

BEST Paper Award @ MobiCom 2017

Zhijun Li and Tian He

Computer Science and Engineering
University of Minnesota

Wireless is Everywhere

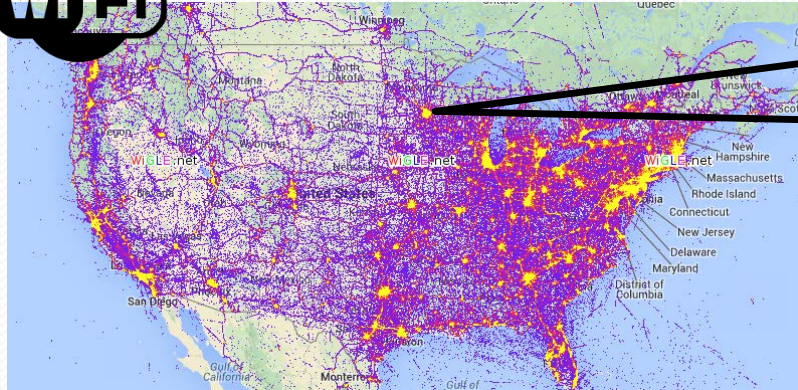

<wige.net>



... and Increases Rapidly

ADOPTION WILL OCCUR RAPIDLY

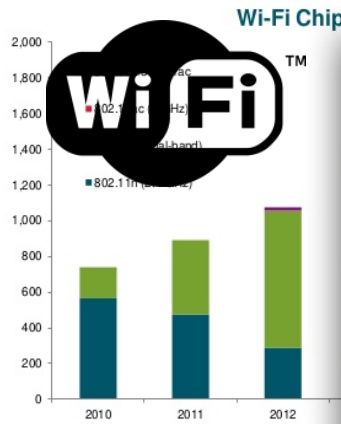

1.8B

~4B

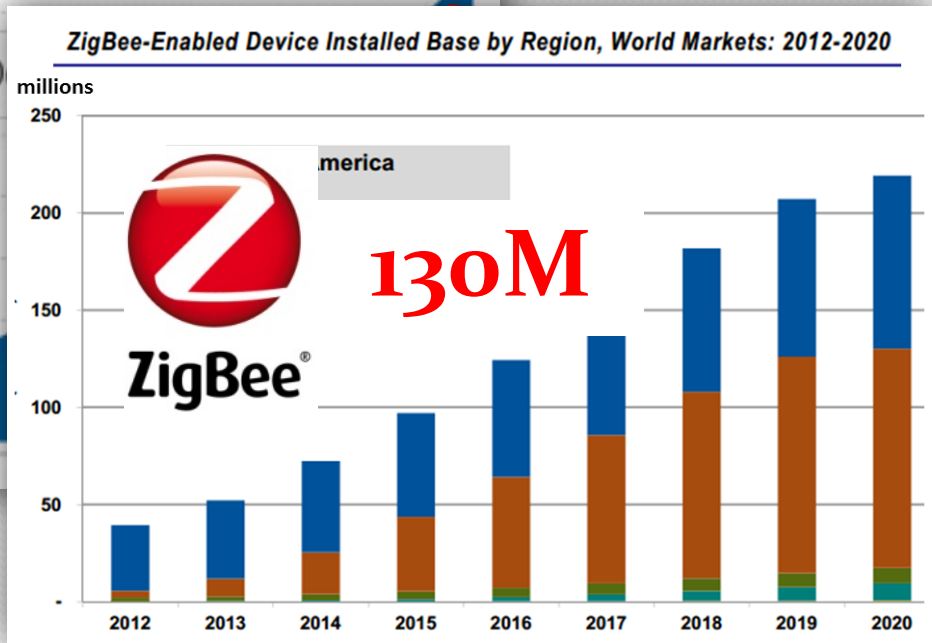
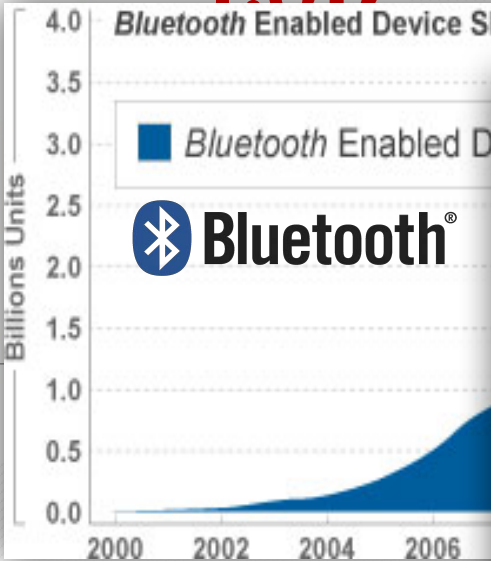

130M

Source: Navigant Research

Gartner predicts 20 billion IOT devices by year 2020

... also Diversifies Quickly

NB-IoT



eMTC



802.11ah
Halow



Coexist and Collaborate

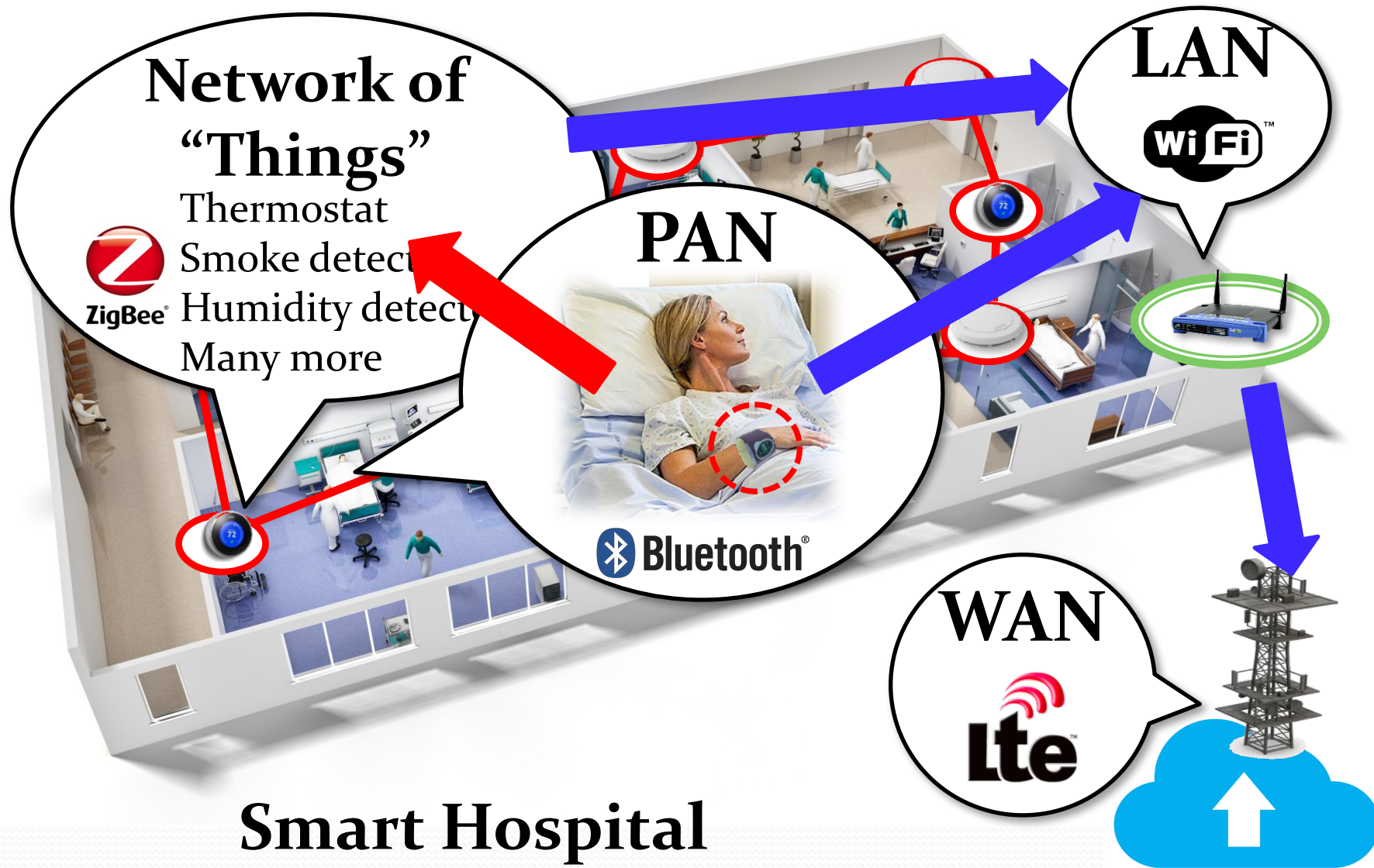

Smart Hospital

Objective: Ubiquitous Connectivity

Q: How to Interconnect/bridge them?

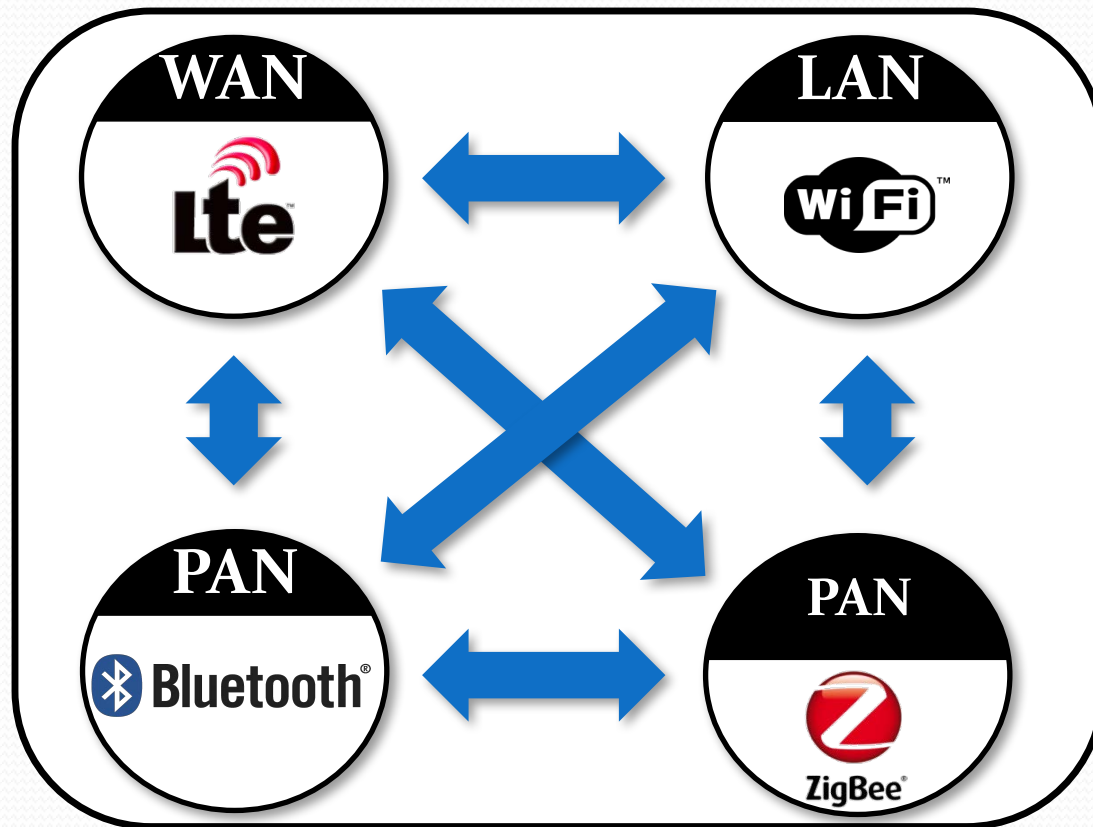

Bridging Wireless Tech: Gateway

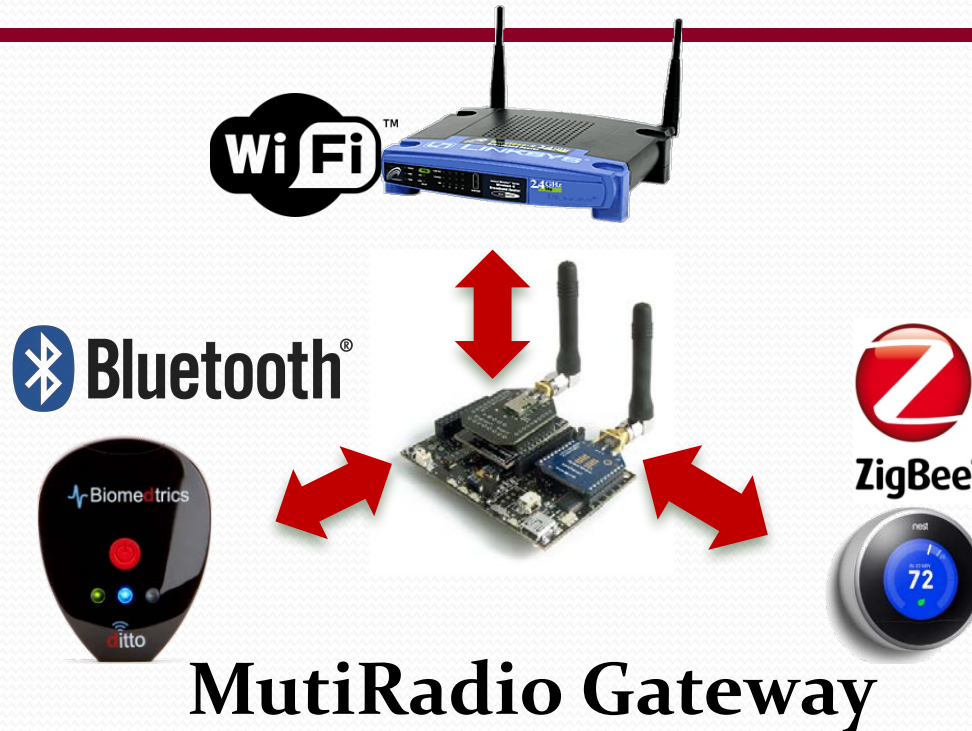

- Extra HW/deployment **cost**
- Traffic **overhead** into/out of the gateway
- Pre-deployment, unsuitable for **ad hoc/mobile**

The New Paradigm: CTC

Cross-Technology Communication (CTC)
enabling heterogeneous devices talk **directly!**



What CTC can Achieve: Low Cost

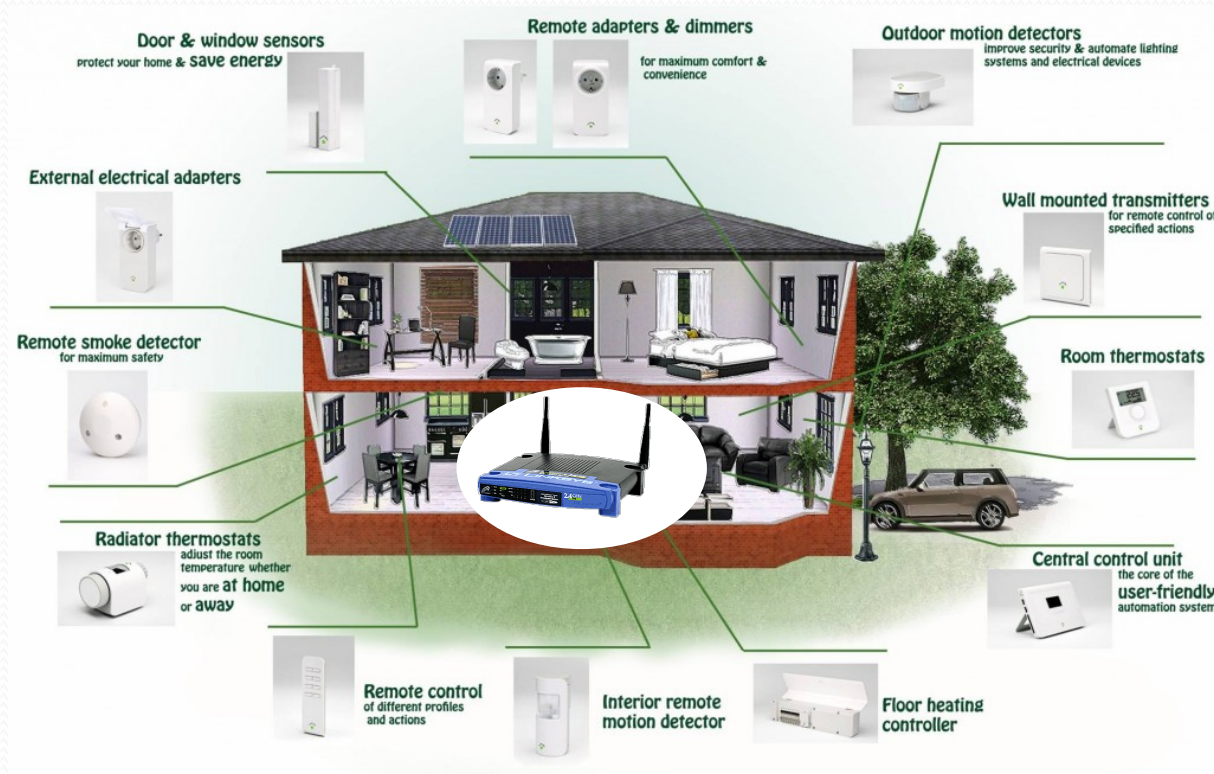

A WiFi AP controls all smart home ZigBee-enabled devices **in one hop without gateway**

What CTC can Achieve: Mobility

VANET

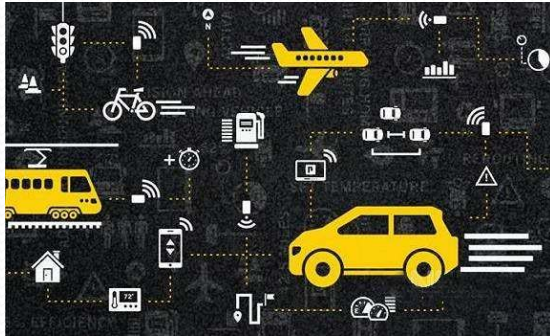

Battle Field

Inventory Tracking

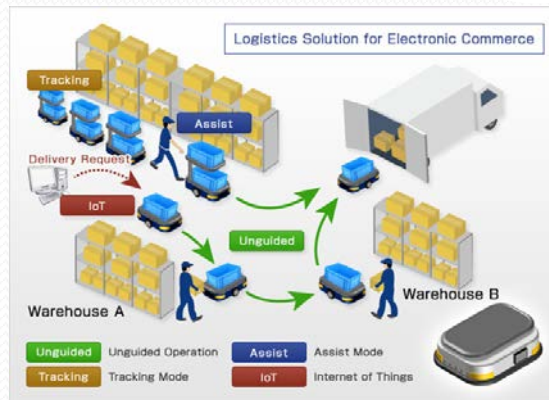

Wearables

Direct Communication among mobile IOT devices without pre-deployed gateways

What CTC can Achieve: Coordination

Support **Explicit** channel coordination

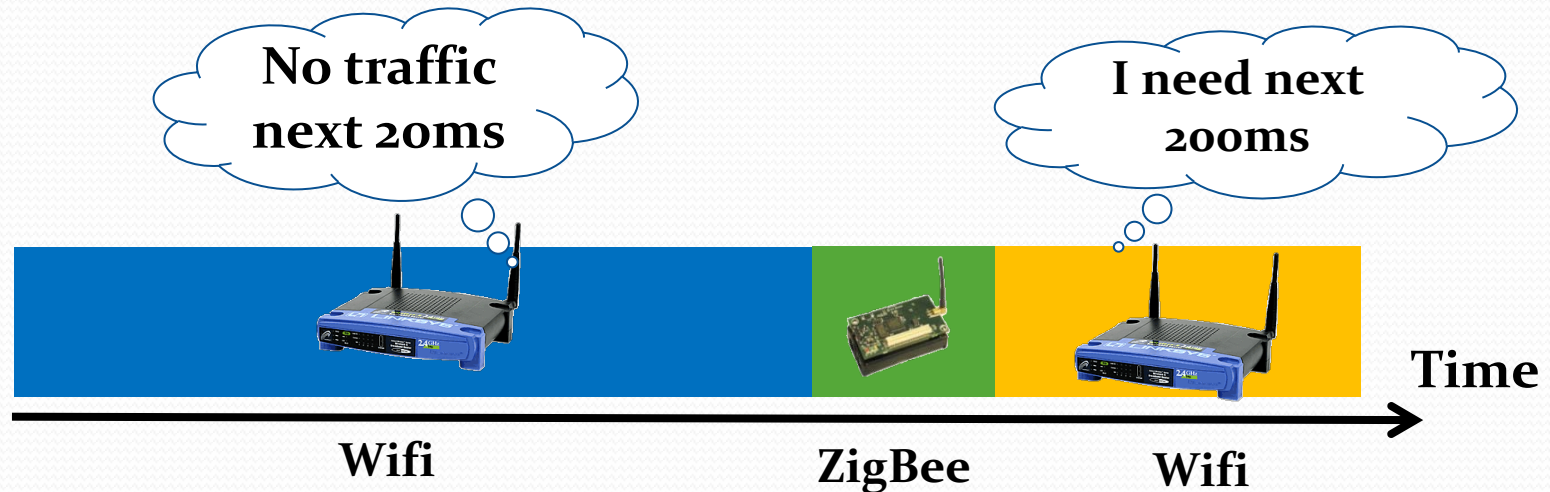

- Extends local mechanisms **globally** across wireless tech
 - Global RTS/CTS Reservation.
 - Global Time Division Multiple Access (TDMA)

WEBee

Physical-Layer Cross-Technology Communication



WEBee: WiFi Emulated ZigBee

Outline

- The State of the Art
- The Design
- Implementation & Evaluation
- Extensions

The State of the Art

A Brief History of CTC Research

Packet-level CTC

Using packet length, gap, or offset
A packet can only express a few bits

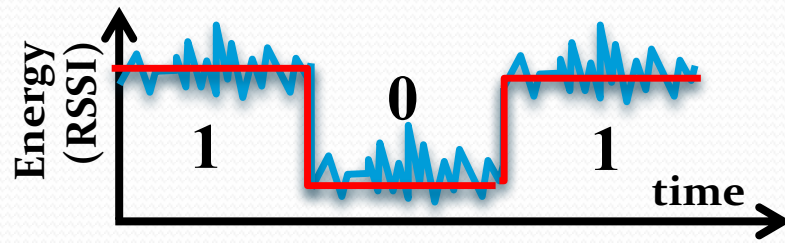

16,000X Faster!!!

WE ARE HERE



**PHY
CTC**

**100S
Kbps**

ESENSE
Packet Length
K. Chebrolu

GSense
Gap Length
X. Zhang

HoWiES
Comb. Packet
Length
Y. Zhang

FreeBee
Beacon Interval
S. Kim

bps

bps

bps

Mobicom
2009

INFOCOM
2013

MobiCom
2015

MobiCom
2017

A Brief History of CTC Research

Physical-Level CTC

By emulating receiver's RF waveform,
A packet achieves Rx's maximum rate

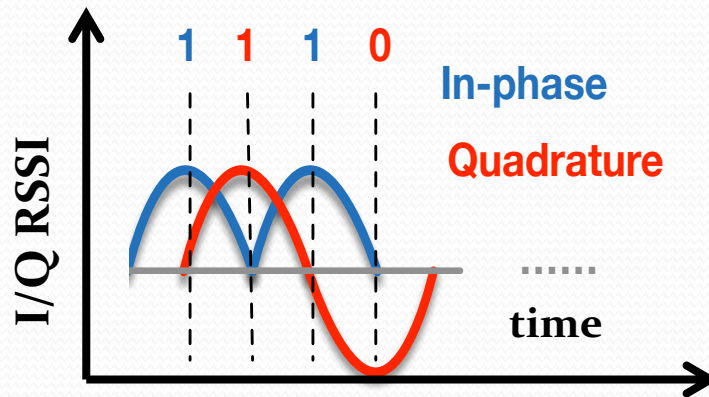

16,000X Faster!!!

WE ARE HERE



**PHY
CTC**

**100S
Kbps**

bps



Mobicom
2009

bps



INFOCOM
2013

bps



MobiCom
2015



MobiCom
2017

The Design



The Key Idea of WEBee

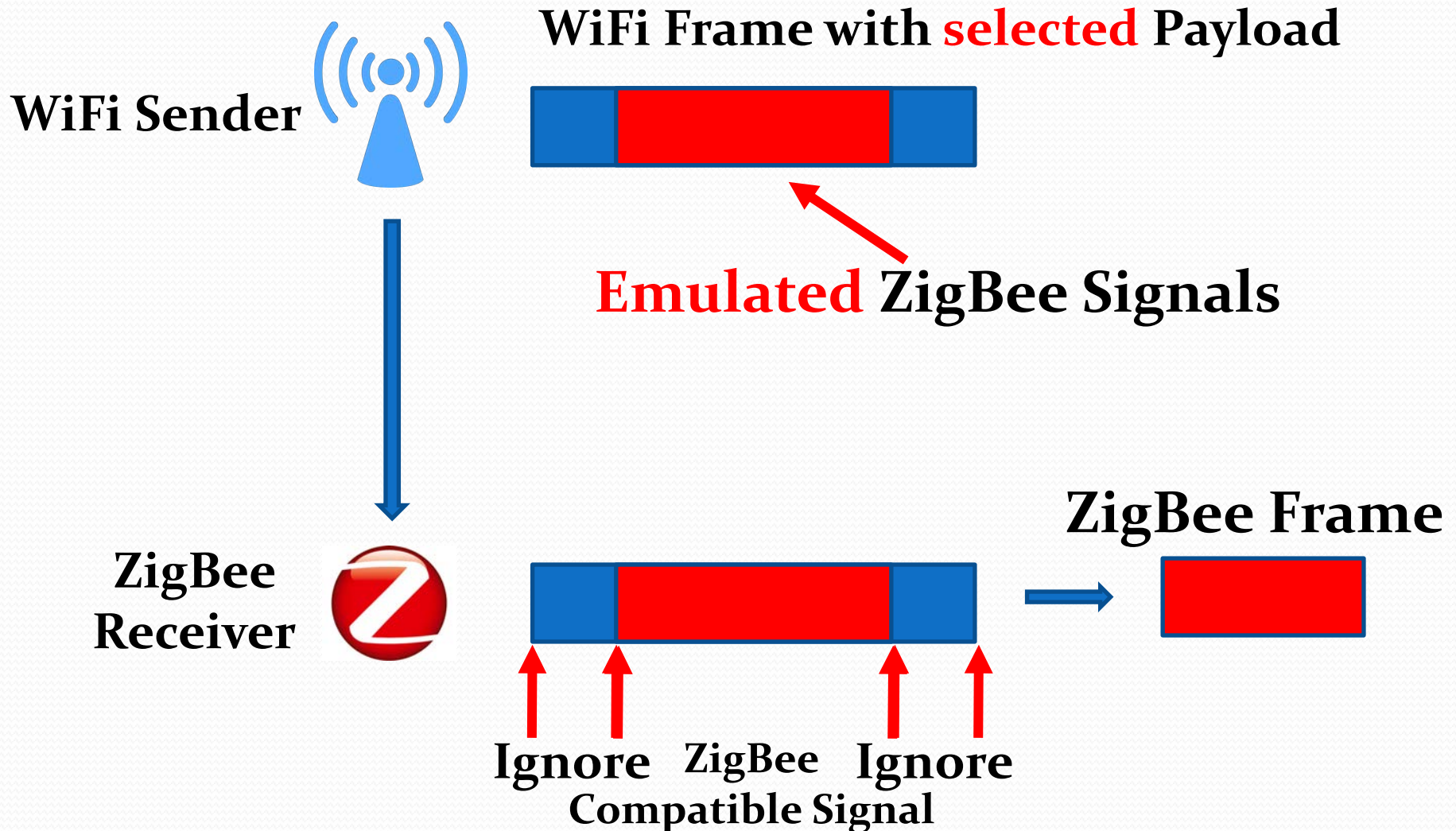

Challenges of Physical-Layer CTC



Modulation: QAM, OFDM
Rate: ~54Mbps (802.11g)
Distance : 300m
Tx : 26dBm
Sensitivity : -80dBm



Key Innovation
Signal
Emulation
@
Wi-Fi Sender



ZigBee®

Modulation : OQPSK, DSSS
Rate: ~250Kbps
Distance : 100m
Tx : 0dBm
Sensitivity : -97dBm



Without translator

How Wi-Fi Transmits

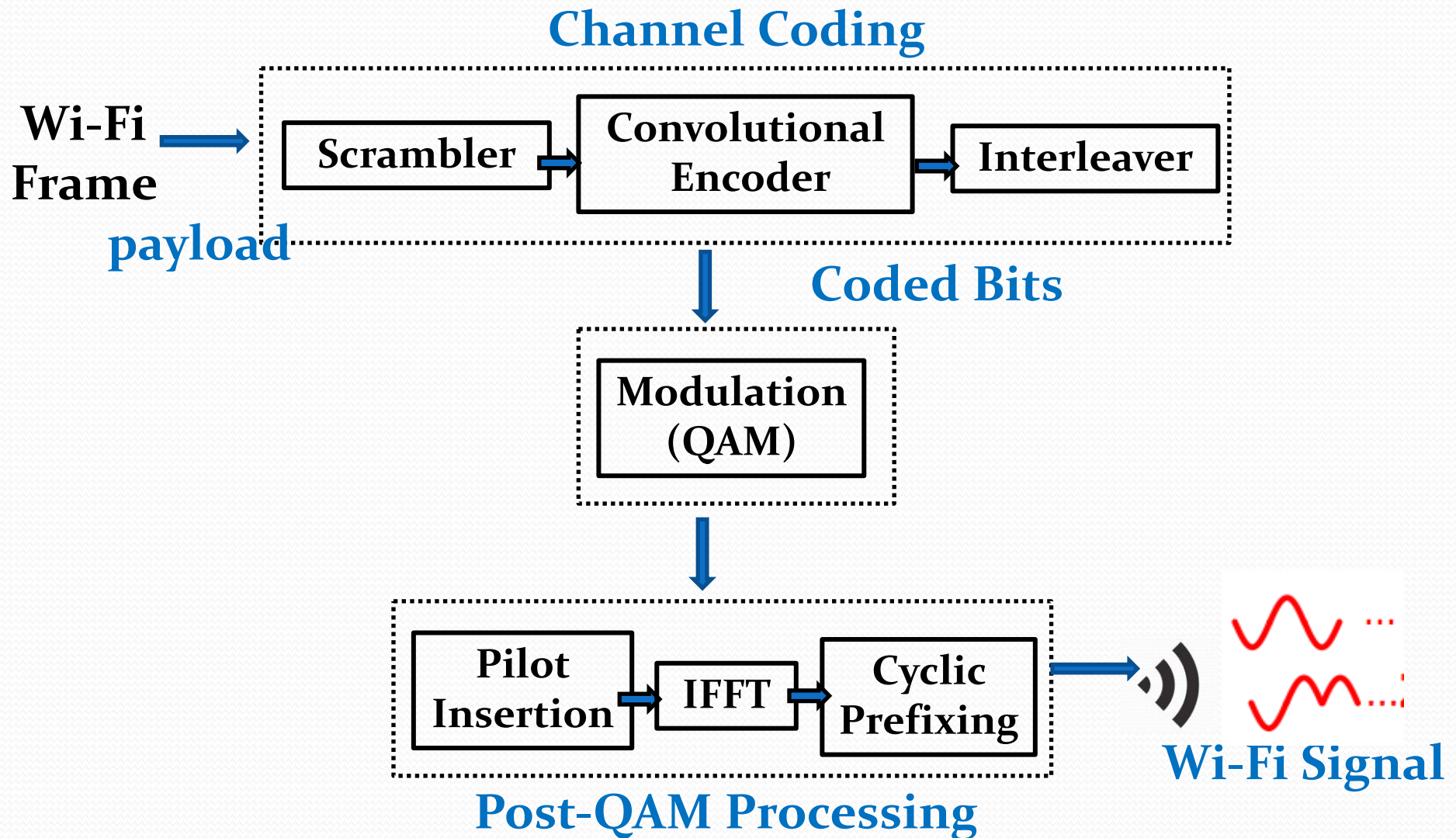

Emulation via a Reverse Path

Channel Coding Emulation

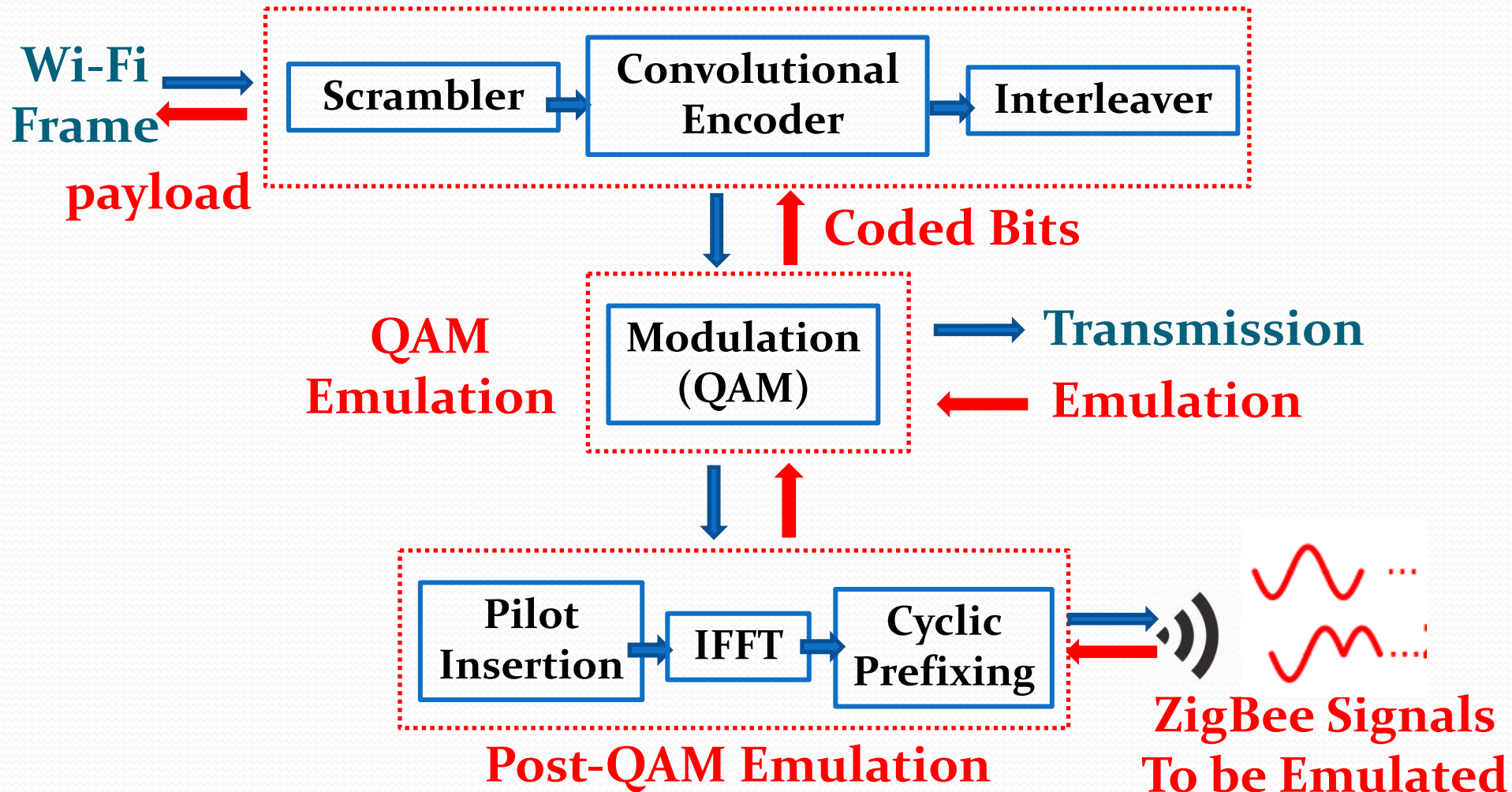

QAM Emulation

RF Signal Spectrogram in the Air

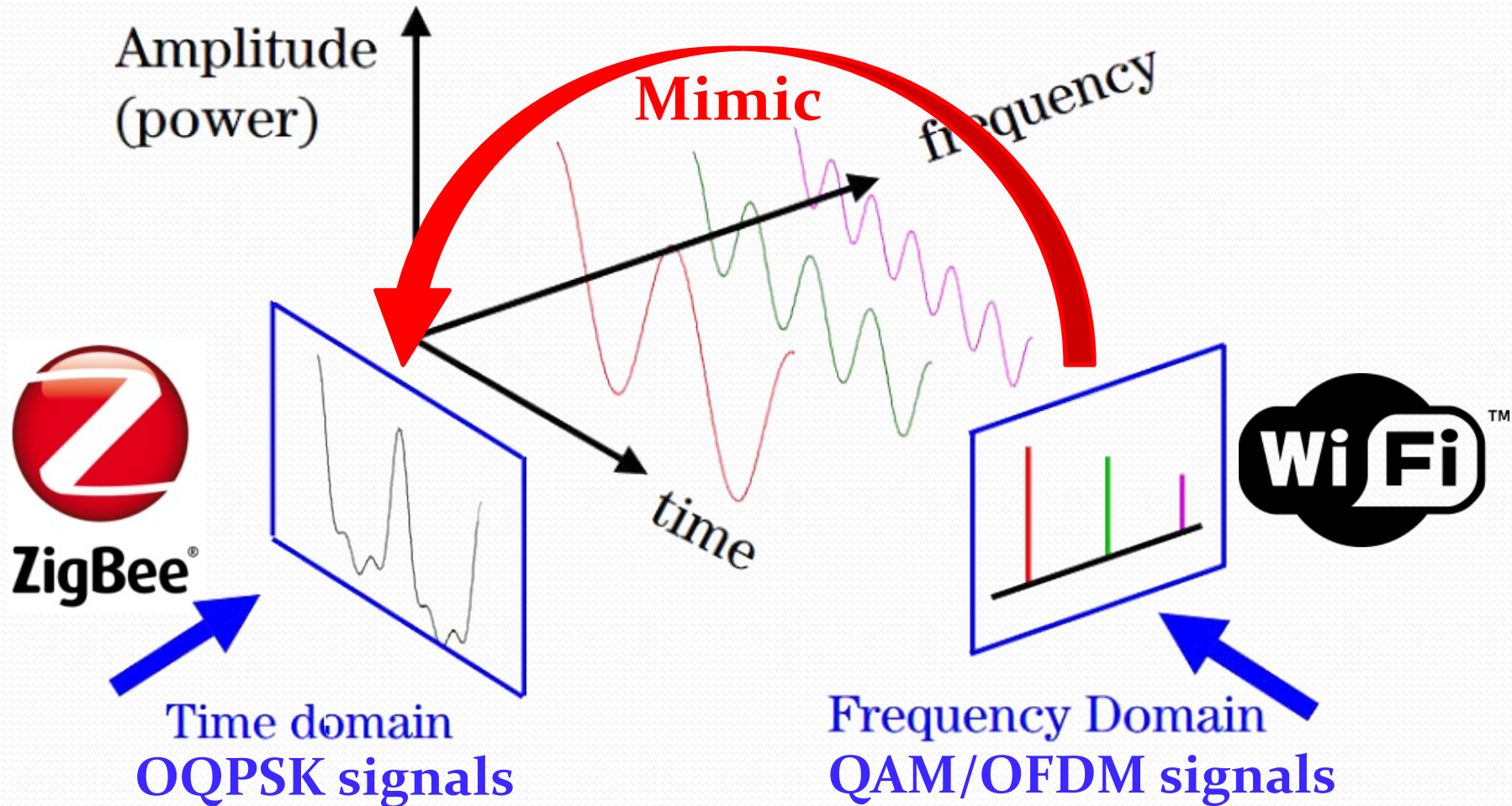

Minimizing Emulation Distortion

- Minimizing emulation distortion in the **time-domain** is equivalent to minimizing the total deviation of **frequency** components (based on Parseval's theorem)

$$\int_{t=-T/2}^{T/2} |u(t) - v(t)|^2 dt = T \sum_k |U[k] - V[k]|^2$$

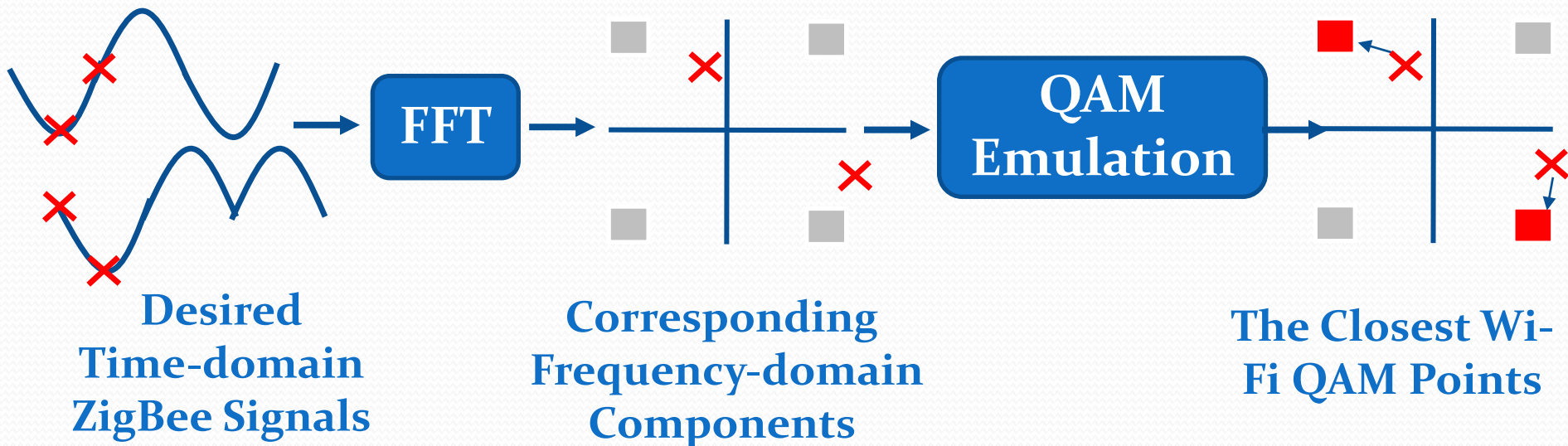

Other Technical Challenges

Reverse channel coding

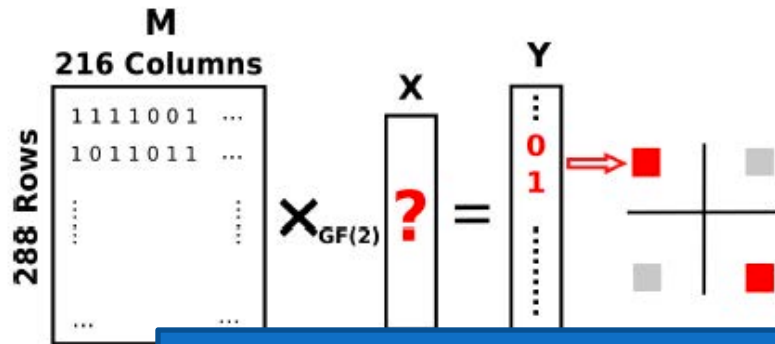

Parallel CTC

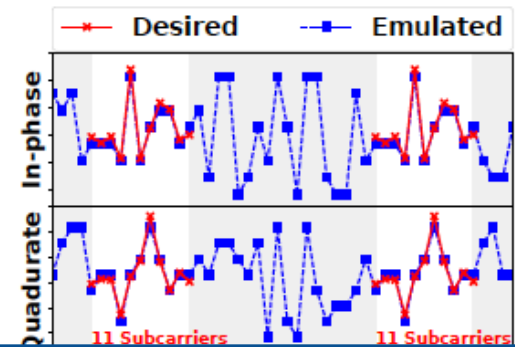

For details, refer to the paper

Pilot/null avoidance

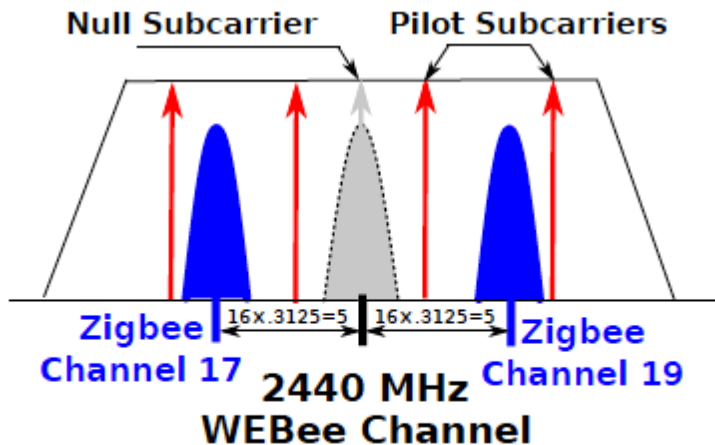

Link-level reliability

WEBe Frame Format:

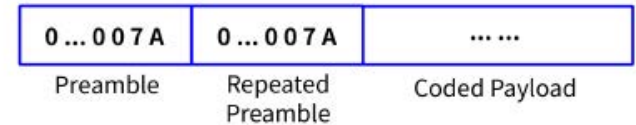

Link Coding:

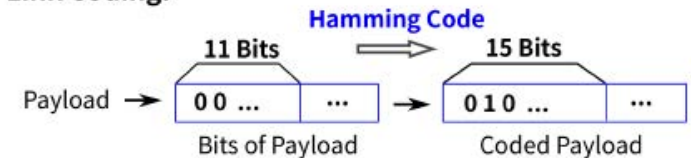

Innovative Features of WEBee

Dual-Standard Compliance



A part of WiFi frame is a Zigbee frame

No change in Sender's Hardware/Firmware



*Send a normal **WiFi** Frame*

*No change in receiver's
Hardware/firmware*

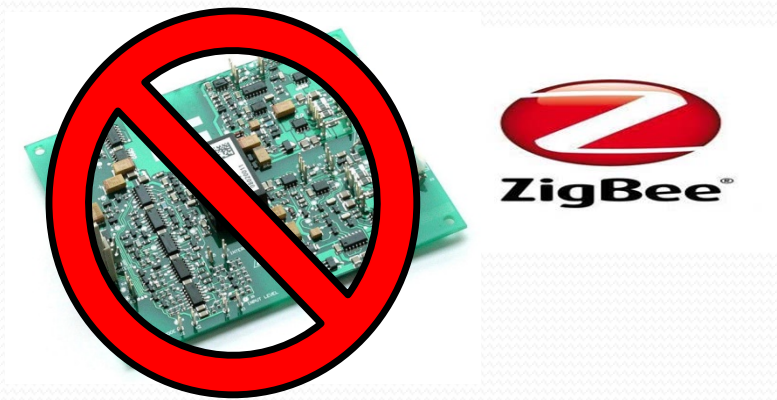

*Receive a normal **ZigBee** Frame*

Combine the advantages of two technologies.



Tx : 26dbm
Sensitivity : -65dbm
Big Mouth



Rx : 0dbm
Sensitivity : -97dbm
Good Ear

WEBee has a longer range than Wi-Fi!

Support parallel CTC in one WIFI Packet



20MHZ



2MHZ



2MHZ

Simultaneous Unicast

Support high mobility and duty cycled operations



Longer Range, better mobility

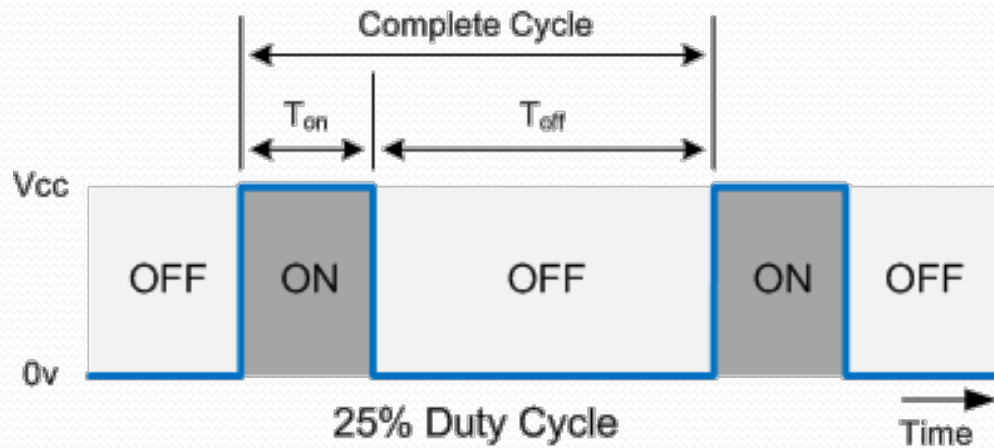

Low Power Listening

*An 16,000x faster CTC
with 99.9% reliability*



For details referring to our mobicom 2017 paper

Implementation & Evaluation

System Implementation

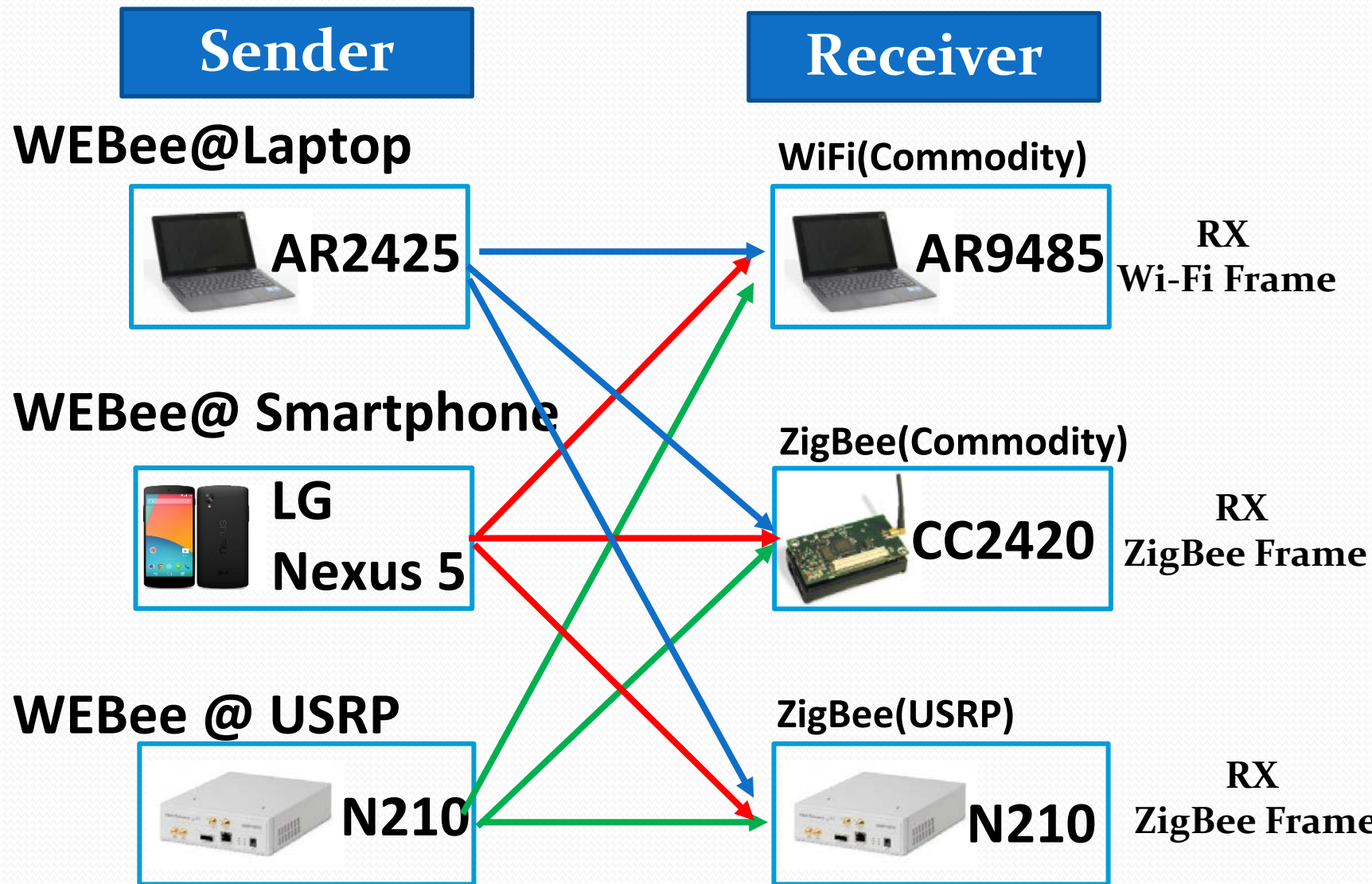

Experimental Setting

- Lab
- Hallway
- Outdoor

Experiment setting

10,000 runs each trial

- Varying distances
- Varying Tx Power
- Varying packet length
- Varying content
- Varying duty-cycle
- Varying Mobility

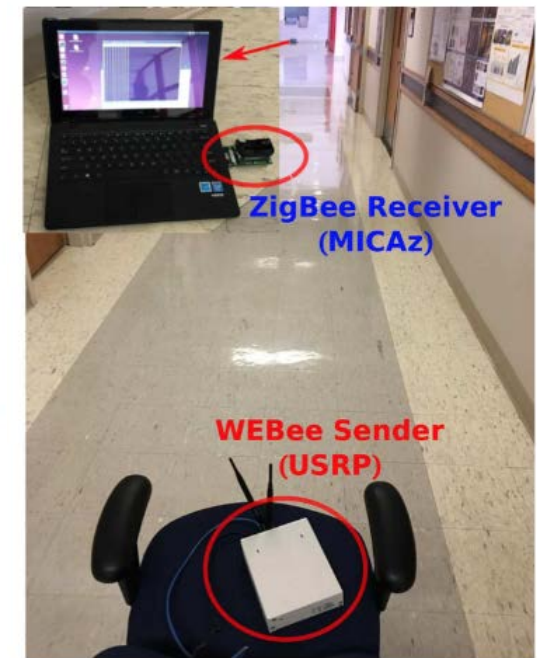
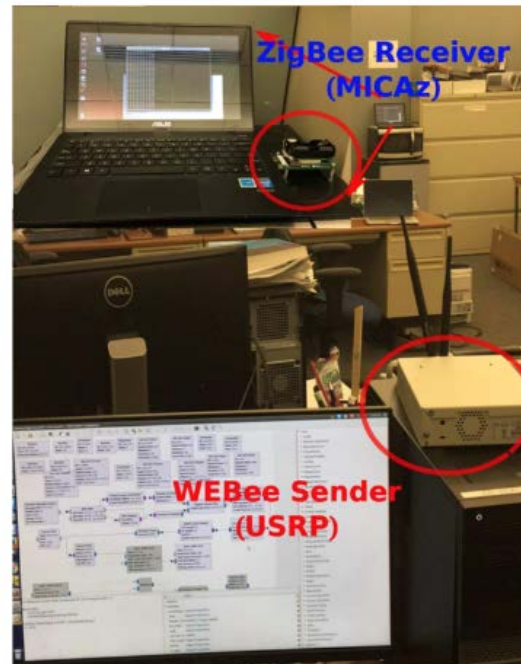

Symbol Error Ratio vs Data Rate

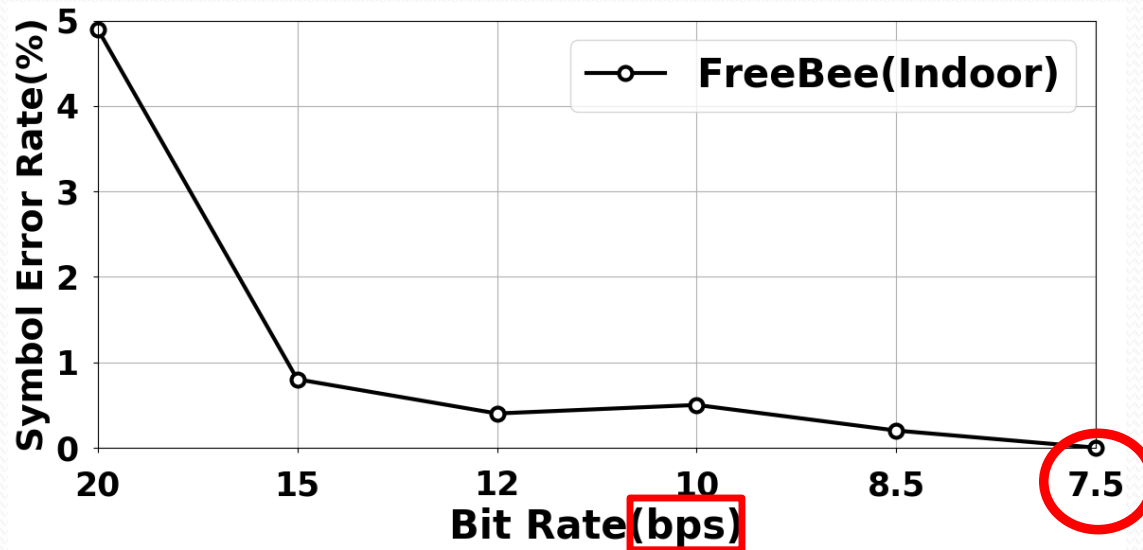

FreeBee [Mobicom '15]

7.5bps @ 99%

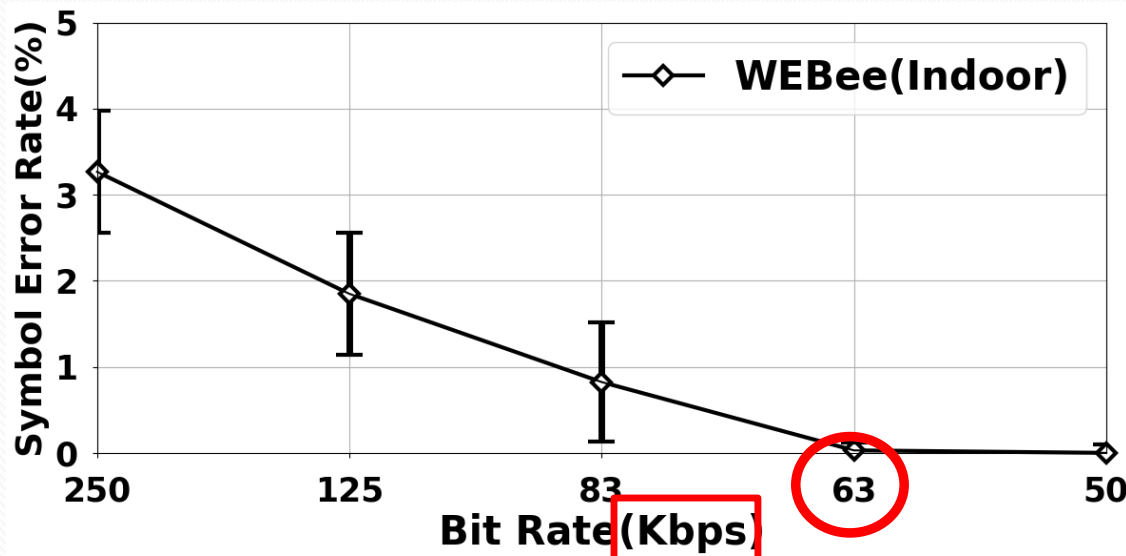

WEBee [Mobicom '17]

63,000bps @ 99%

~8,000x Speed up

*250kbps theoretically

Frame Reception Ratio

A frame fails with one symbol error

WEBee(Commodity)



ZigBee



WEBee(USRP)

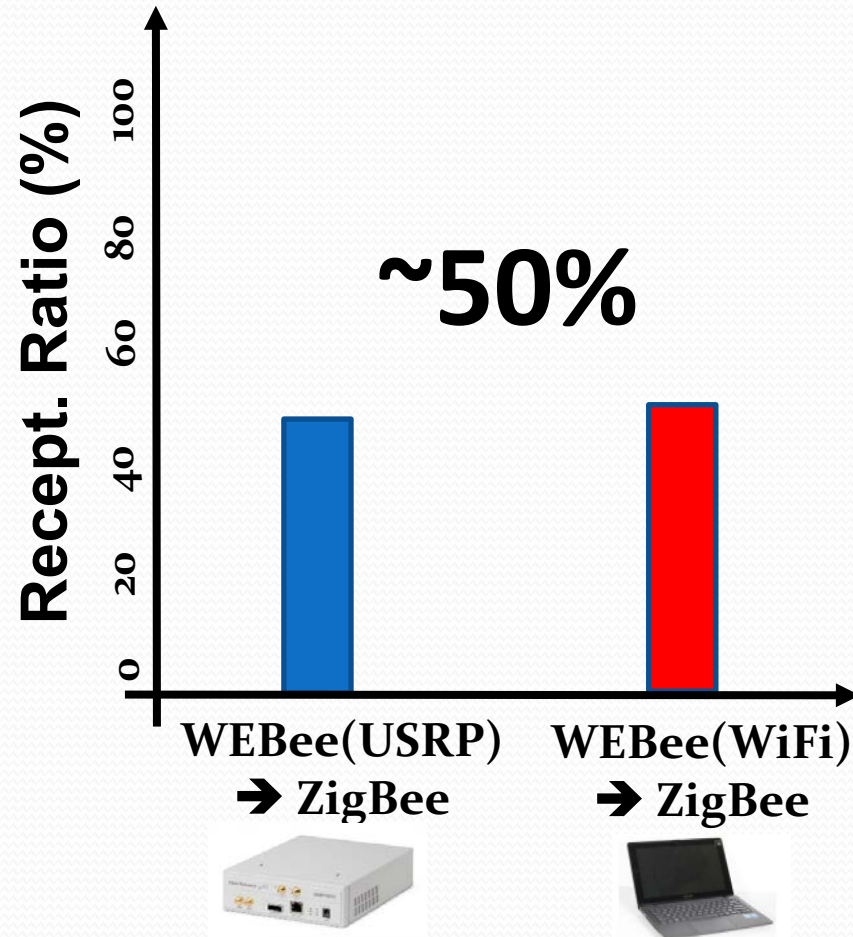

Reliability after Retransmission

99% after 6 retransmissions

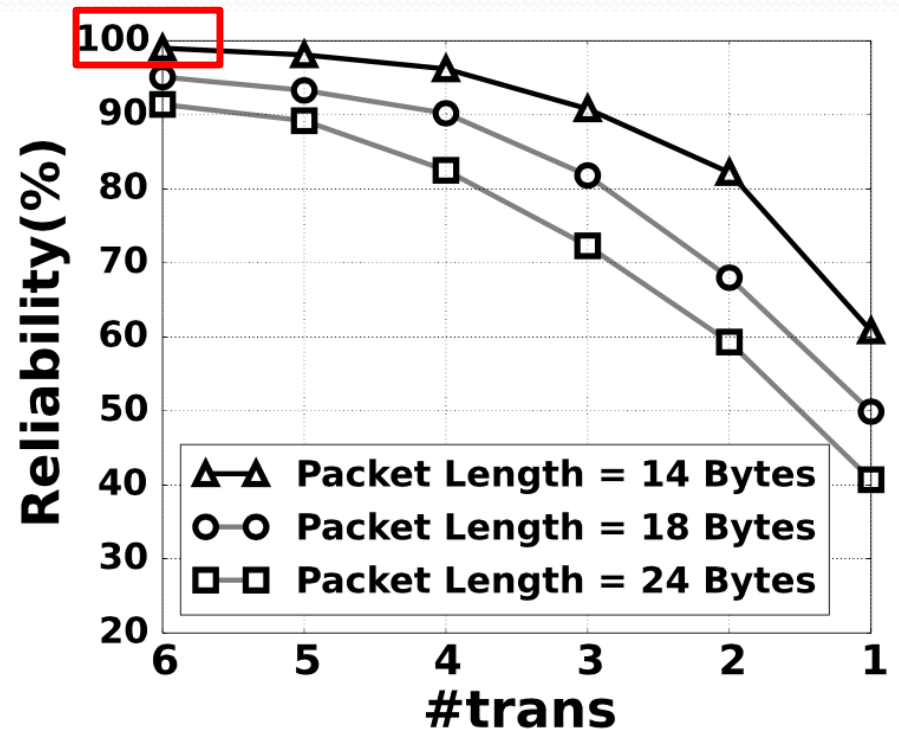
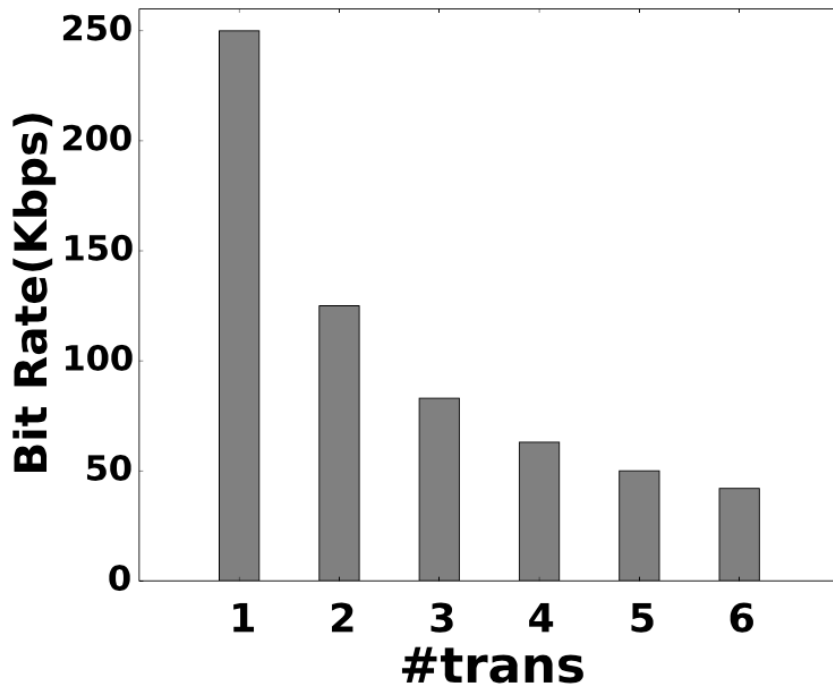

Less re-TX with Repeated preamble and coding

Parallel CTC

With two channels, WEBee vs. FreeBee = $\sim 16,000x$

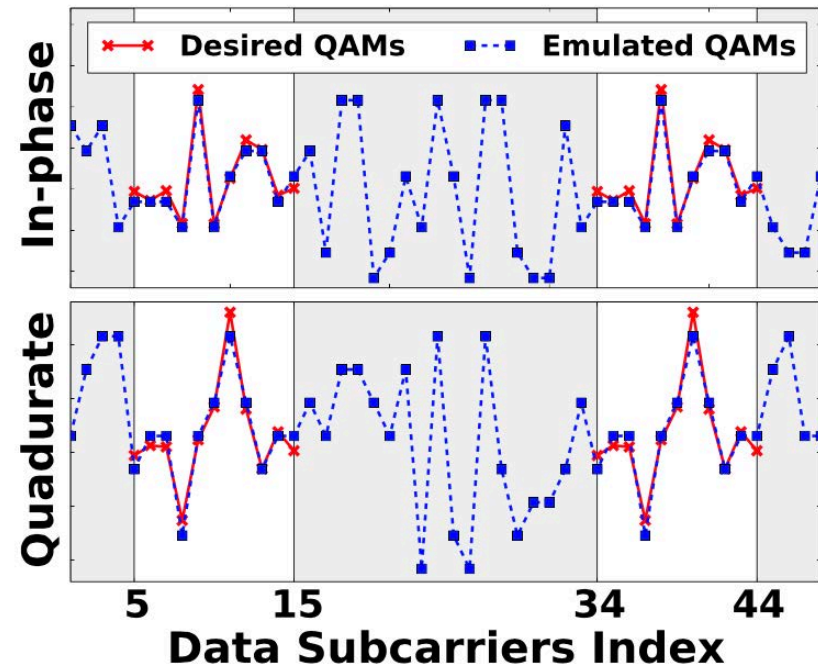
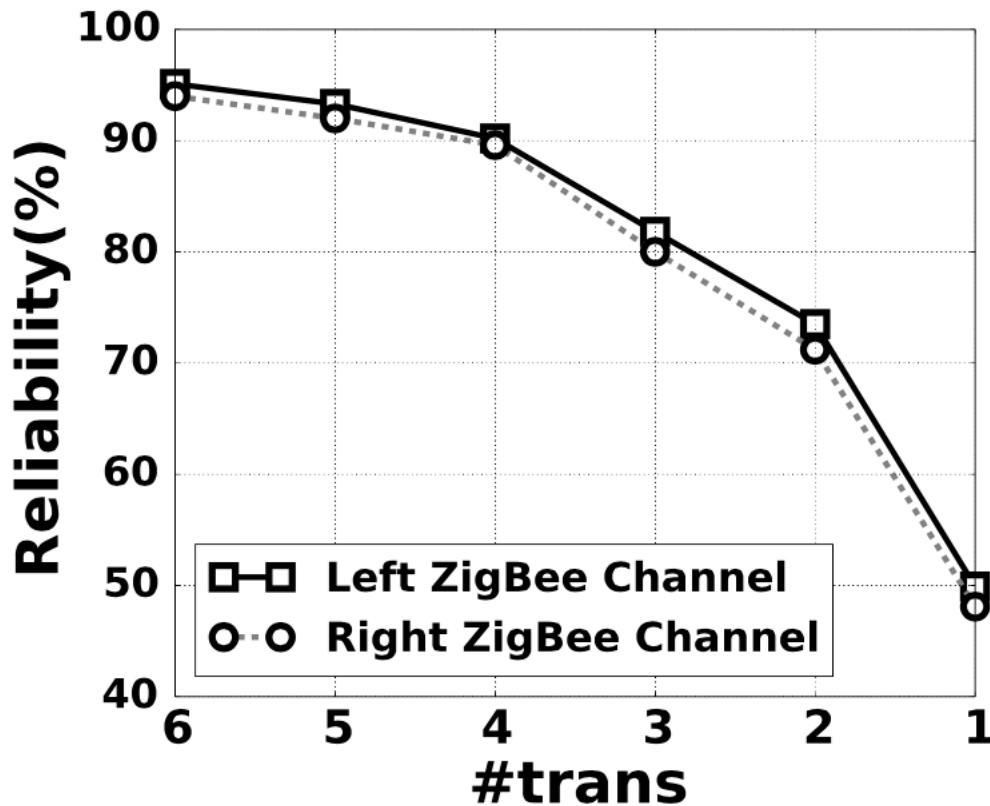

Channel I

Channel II

WEBee in Action

WEBee Demo

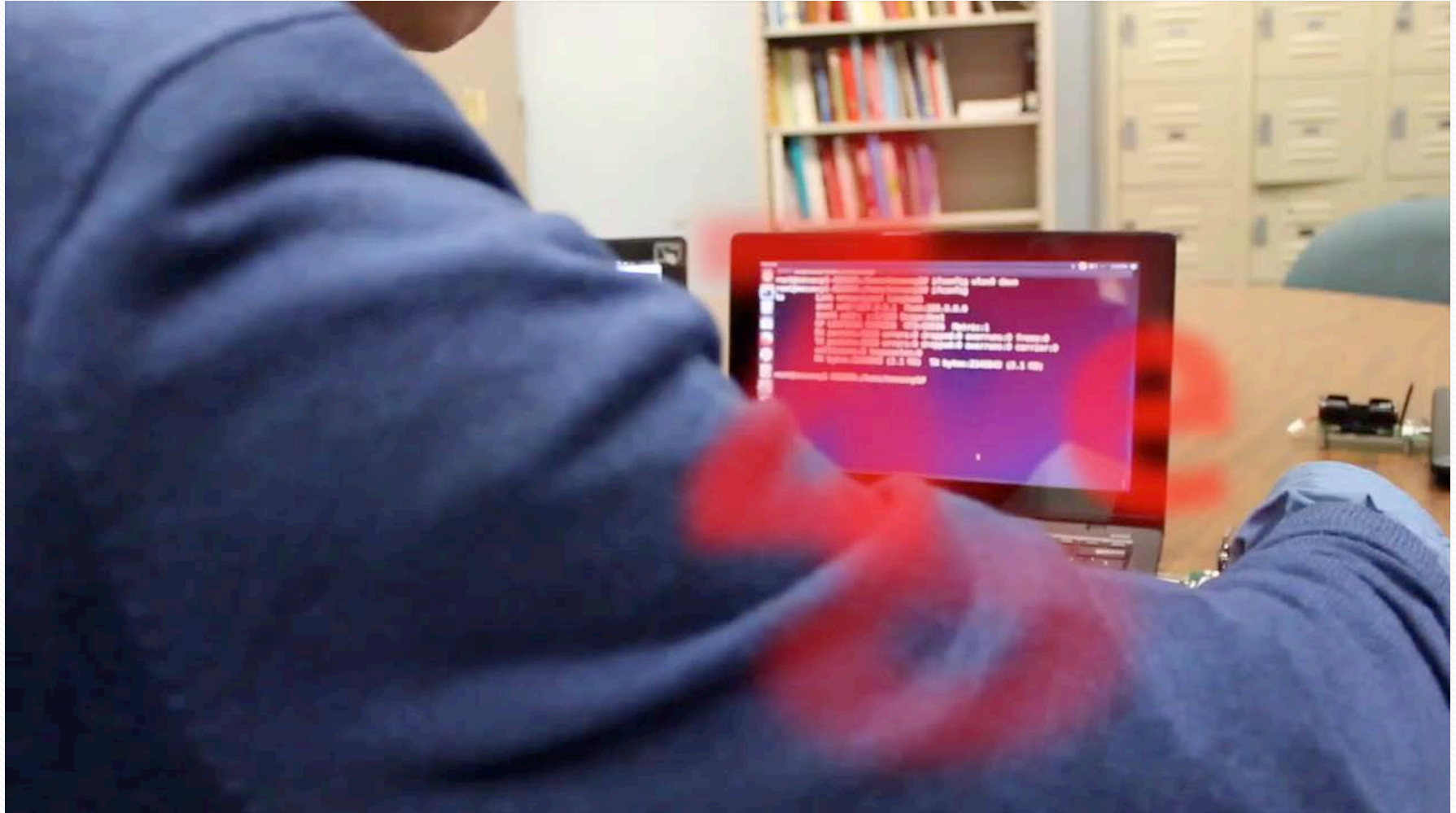

Application: Smart Light Control

- You can control ZigBee Smart Bulb with WEBee



GE Gateway Solution

Vs.

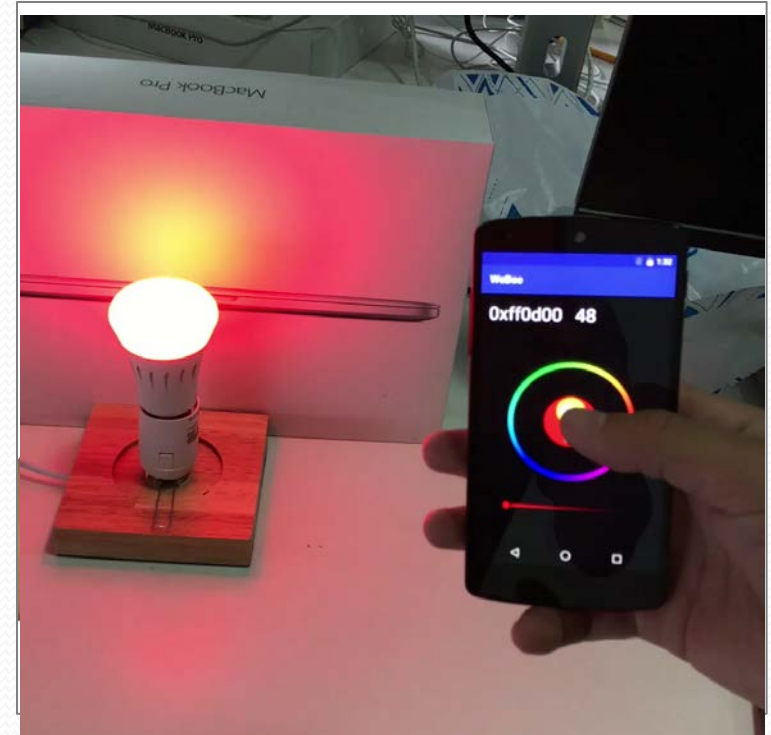

WeBee Solution

Release: WEBee Payload Generator V1.0

You can conduct cross-technology research using WEBee Generator!

Available at: <http://tianhe.cs.umn.edu/CTC>

Possible New Topics:

- Channel Access Control
- Coordination
- Neighbor Discovery
- Multi-Technology Routing
- CTC Time Synch.
- CTC Localization
-

WEBee: Physical-Layer Cross-Technology Communication via Emulation

WEBee Frame Generator

ZigBee Symbols:

Entered Zigbee symbols will be used to fill the PHY Service Data Unit (PSDU) in the WEBee packet.

WiFi Injector:



Scramble Seed:

WiFi Payload

WEBee payload will appear here

Usage Description

The WEBee Frame Generator can generate the WiFi frame for any ZigBee frame.

1. Enter the ZigBee symbols in the following format: 0,0,0,0,0,0,0,7,10,3,0,5,5,5,5,5
2. Choose the WiFi frame injector used in your WEBee sender. (WiFi injector types supported currently include Socket with UDP protocol, Socket with TCP protocol, and Lorcon.)
3. Click on the "Generate" button

Extension

Question:

Whether Signal Emulation
is a generic technology?

BlueBee: BlueTooth to ZigBee [SenSys '17]



LTEBee: LTE (band 7) to ZigBee

- LTE smartphone controls a CC2530 ZigBee Blub directly after 7-layers channel coding and 6-step modulation.

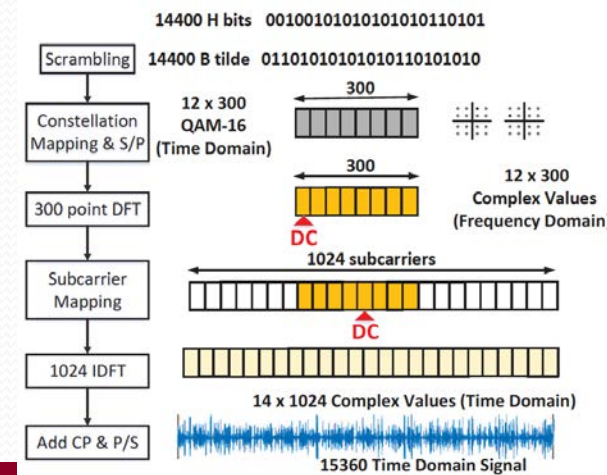
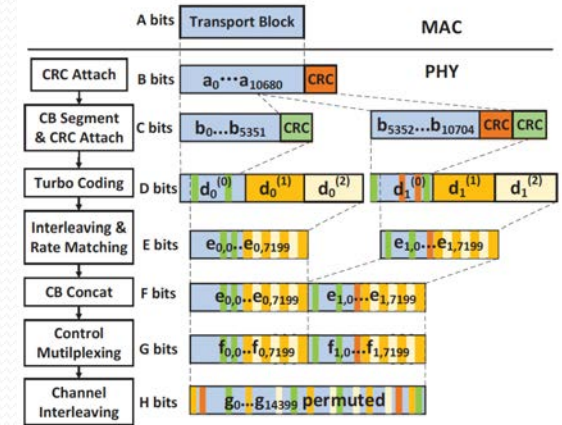
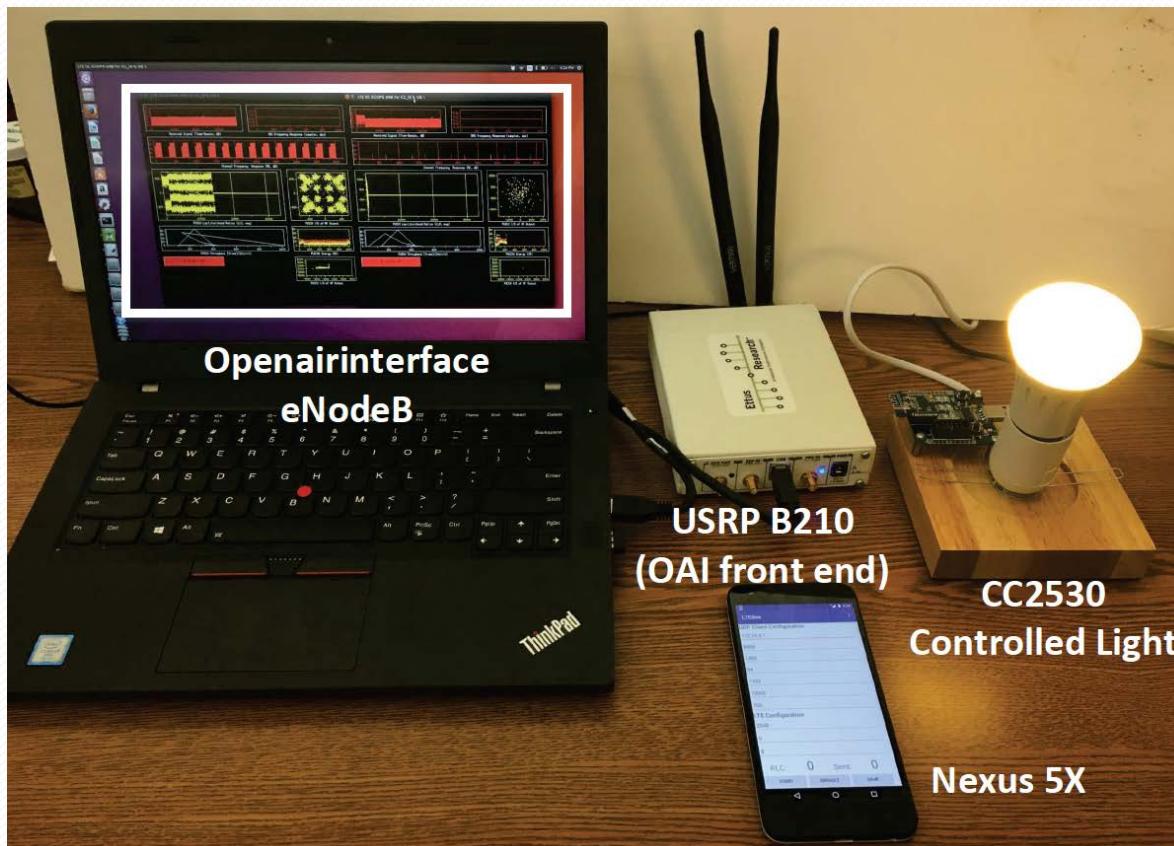

Conclusion

- WEBee is the **first physical-layer CTC design**, a paradigm shift with a significantly higher throughput, while requiring no change of HW.
- Our work indicates **Signal Emulation is a generic technology** to build light-weight SDR, striking a delicate balance between flexibility and cost.
- Our work brings a surge of opportunities to **expand many local wireless mechanisms globally** (e.g., coordination, discovery, etc.) across technologies.

Thank you!!

Questions?

CTC Technical Support is available at

<http://tianhe.cs.umn.edu/CTC>

Can support two-way

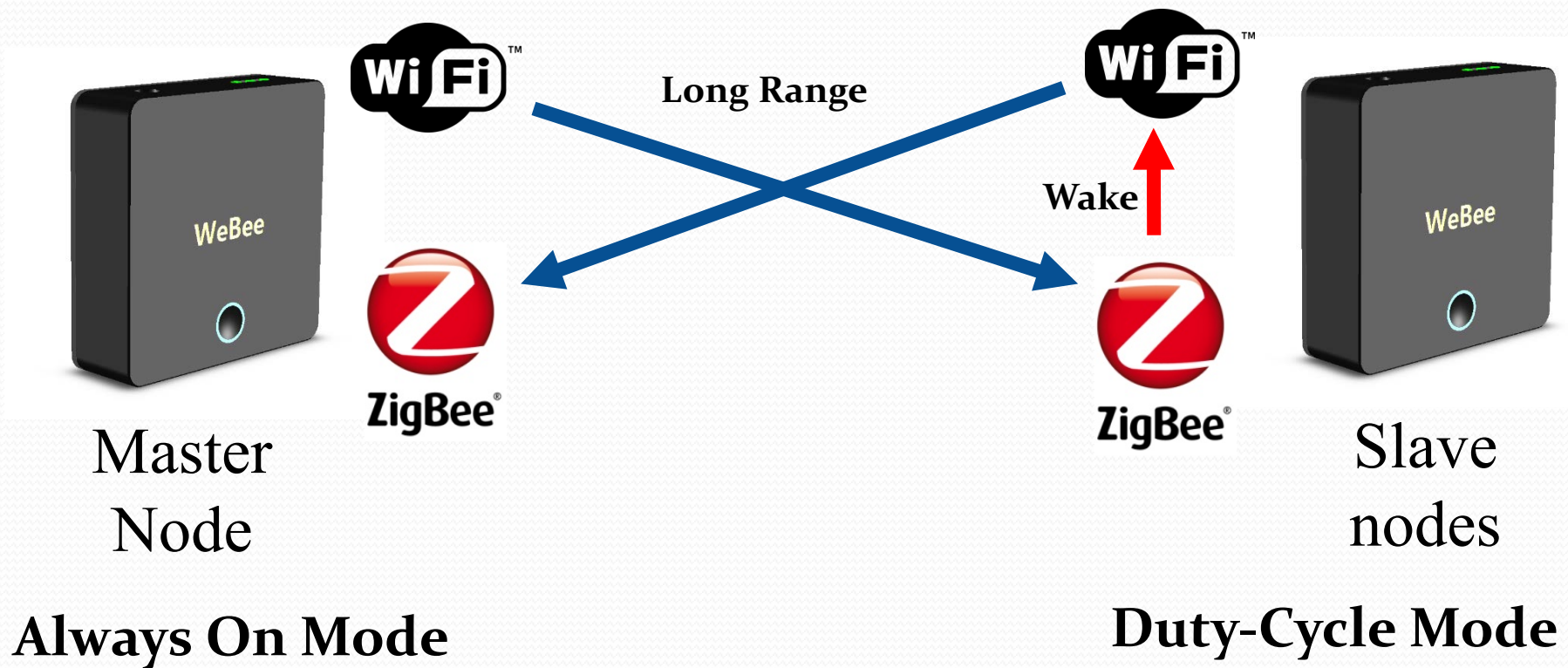

Opportunity for Cross-Tech.-Comm.

- Wireless technologies share unlicensed ISM bands, offering opportunity for **cross-tech. communication**

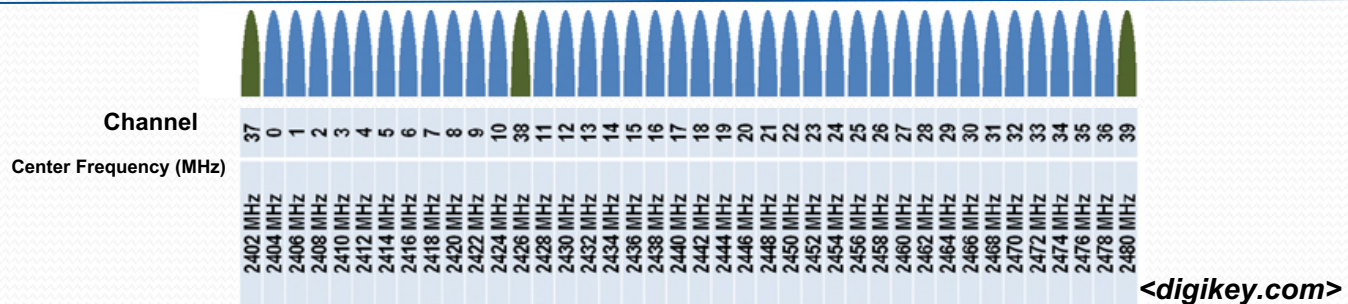
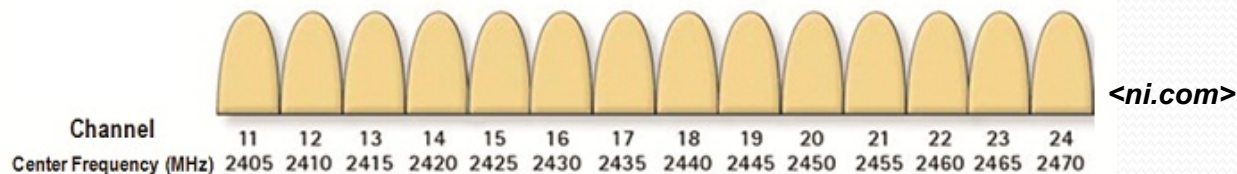
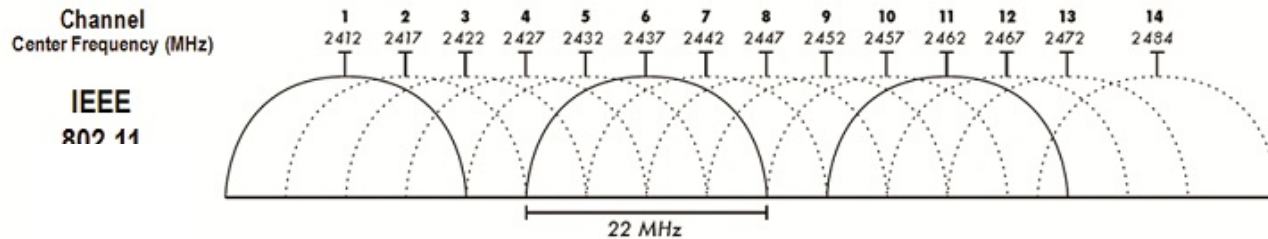

2.4G ISM

Channel Mapping

- OFDM Has 64 subcarrier, 48 data, 12 null and 4 pilot

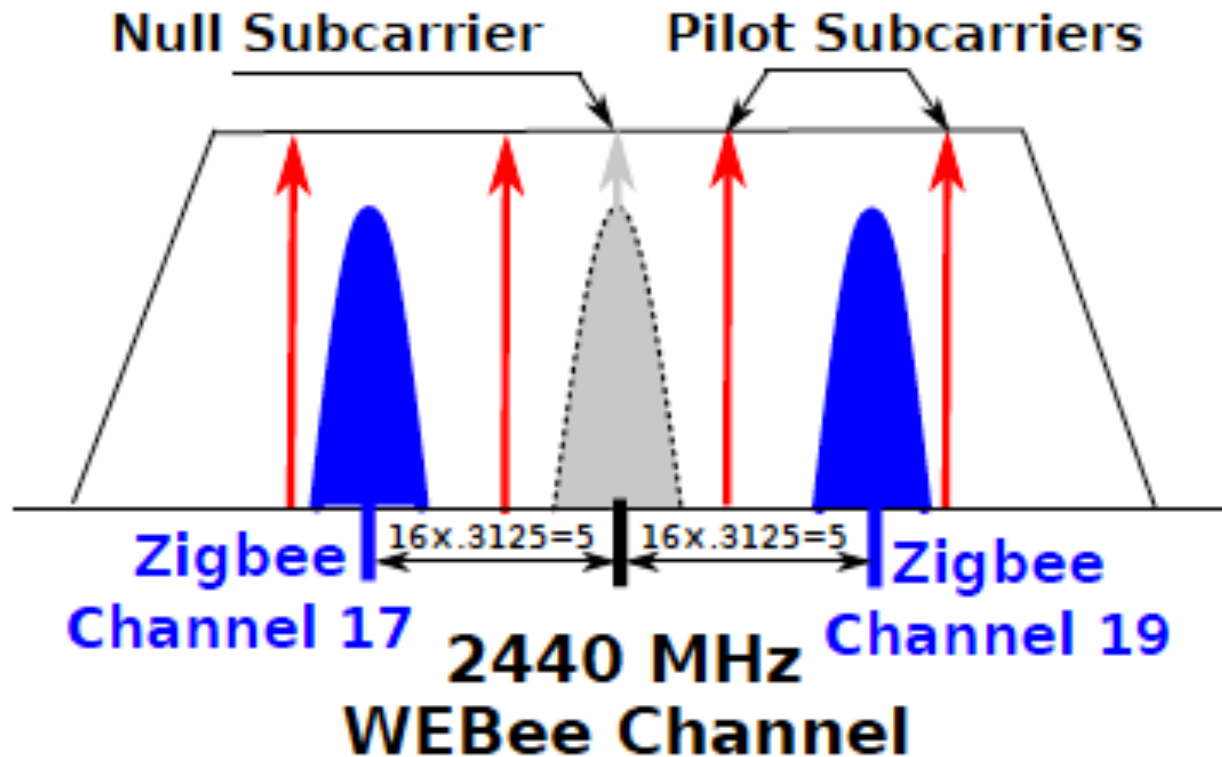

Figure 9: Channels Mapping for Pilot Avoidance

Four-to-one emulation

- Four Wi-Fi symbols are used to emulate one ZigBee symbol

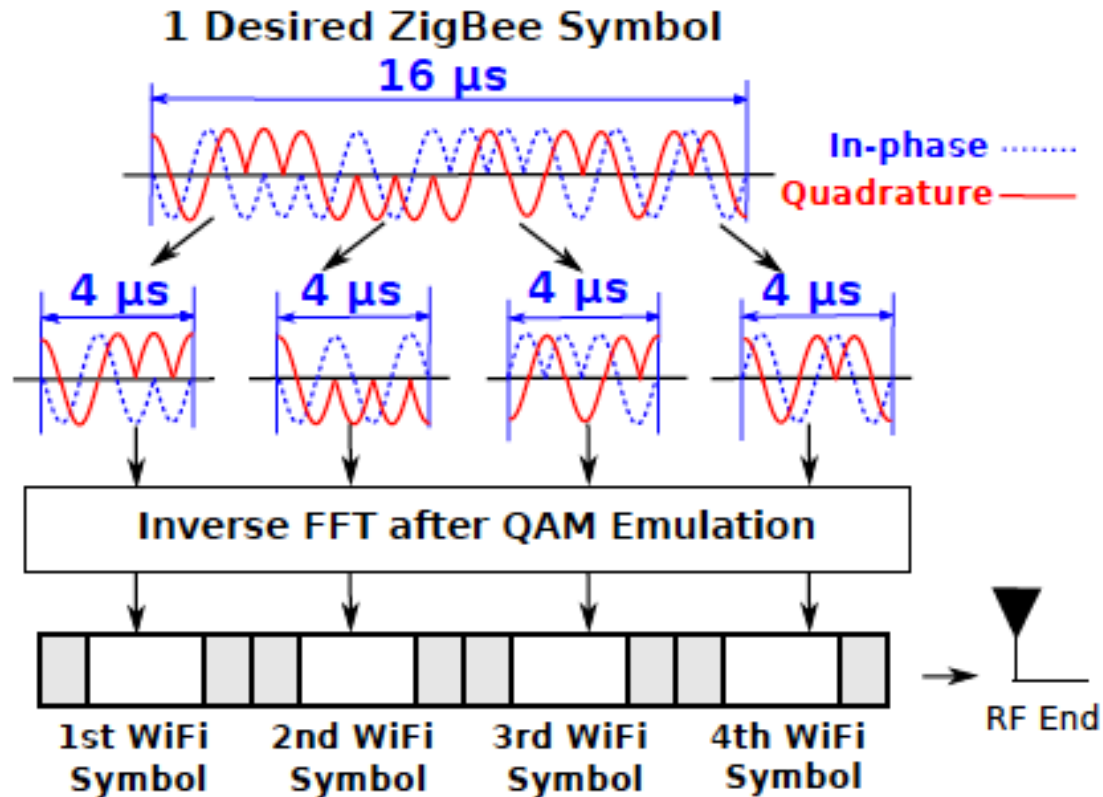
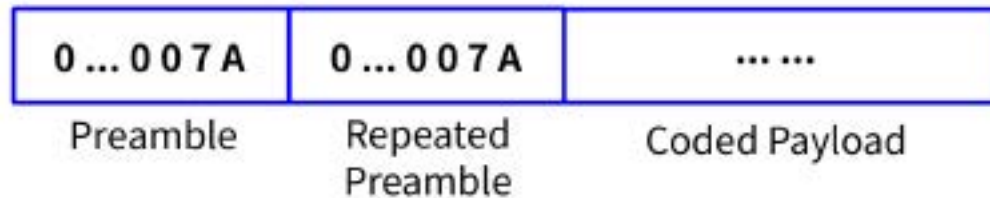

Figure 10: Emulate OQPSK with WiFi QAM.

Link Layer Reliability

- Repeated preamble and hamming coding

WEBee Frame Format:



Link Coding:

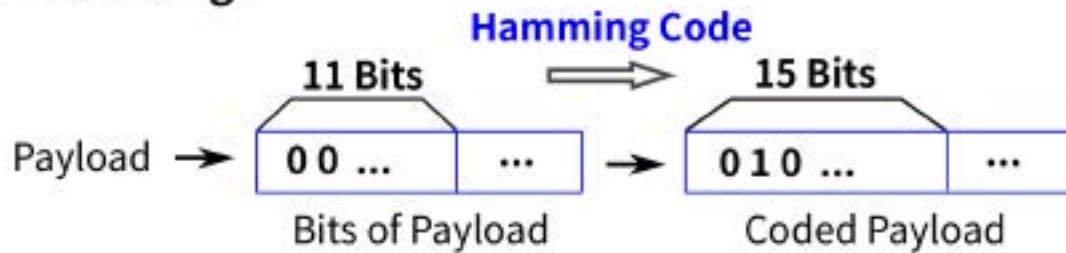

Figure 14: Reliable CTC with Link Coding

